



Model Number

V1-W-E2-YE2M-PVC-U

Cable socket, M12, LED, 3-pin, PVC cable

Features

- Built-in LED, as operating and function indicator
- UL Recognized Component
- Knurled nut suitable for tool assembly
- Immunity to vibration, with mechanical latching
- Gold-plated and machined contacts
- Degree of protection IP67 / IP68 / IP69K
- Flame resistant cable

Dimensions

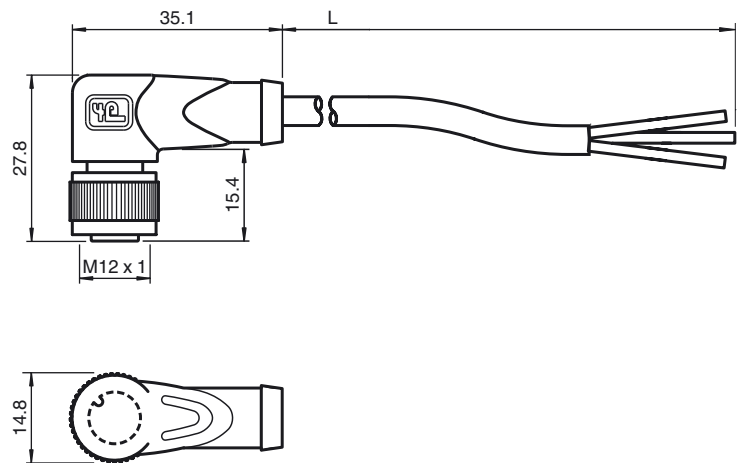

Technical data

General specifications

Number of pins	3
UL File Number	E231213

Indicators/operating means

LED green	Operating display
LED yellow	Functional display NO

Electrical specifications

Operating voltage	U_B	max. 24 V DC \pm 15%
Operating current	I_B	max. 4 A
Volume resistance		< 5 m Ω

Ambient conditions

Ambient temperature	Body: -40 ... 90 °C (-40 ... 194 °F) cable, flexing: -25 ... 80 °C (-13 ... 176 °F) cable, fixed: -5 ... 80 °C (23 ... 176 °F)
Pollution degree	3

Mechanical specifications

Contact elements	spring-loaded contact socket
Pin diameter	1 mm
Degree of protection	IP67 / IP68 / IP69K
Material	
Contacts	CuSn / Au
Contact surface	Au
Body	TPU, transparent
Cable	PVC
Slotted nut	Diecast zinc
Core insulation	PVC
Cable	fine-strand, flexible
Sheath diameter	\varnothing 4.3 mm
Bending radius	> 15 x cable diameter, moving > 5 x cable diameter, fixed
Color	yellow
Cores	3 x 0.34 mm ²
Conductor construction	19 x 0.15 mm \varnothing
Length	L 2 m
Flammability	
Contact carrier	HB
Housing	V-2
Cable	FT1

Compliance with standards and directives

Standard conformity	
Degree of protection	EN 60529:2000
Standards	IEC 61076-2-101:2008

Electrical connection

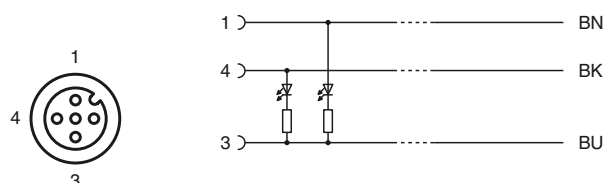



Flammability

Body: UL 94
Line: UL 1581 Section 1061; IEC 60332-1-2:2004

Approvals and certificates

UL approval

cURus AWM 2095 AWM I/II A/B 80°C 300V FT1 (cable)

Release date: 2017-01-20 13:16 Date of issue: 2017-01-20 456408_eng.xml